

T-CBN SERIES

www.tungaloy.com

Tungaloy Report No. 515-G

CBN with **WavyJoint** technology achieves stable machining of hardened steels

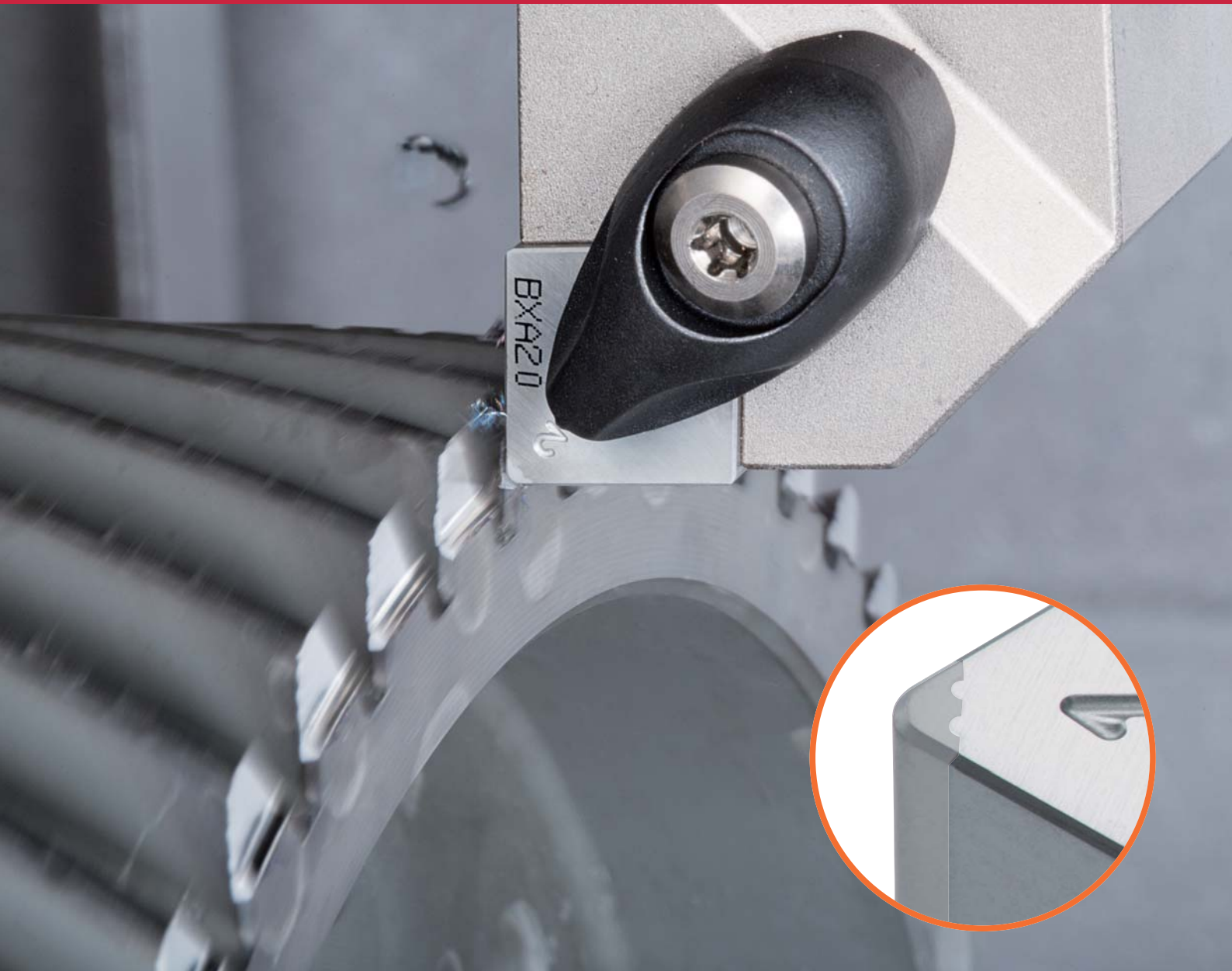

INDUSTRY 4.0
FEED the SPEED!



ACCELERATED MACHINING

TurnLine

T-CBN SERIES

TUNGALOY



Robust as ever! For outstanding performance in hard turning applications.

For **high efficiency** hardened steel machining

New brazing technology for increased machining efficiency - "WavyJoint"

- A maximum depth of cut up to 0.8 mm
→ Reduces the number of passes to increase productivity
- Innovative WavyJoint brazing technology
→ Prevents the CBN tips from debrazing, eliminating abrupt insert fractures during demanding dry machining, while securing stable and predictable hard turning operations.

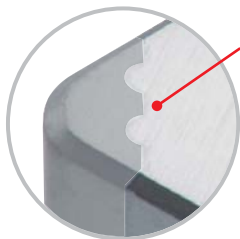

The "wavy" contact surface enhances the brazing strength.

Strong joint

4 cutting edges



WavyJoint BXA20

Vs.

Standard

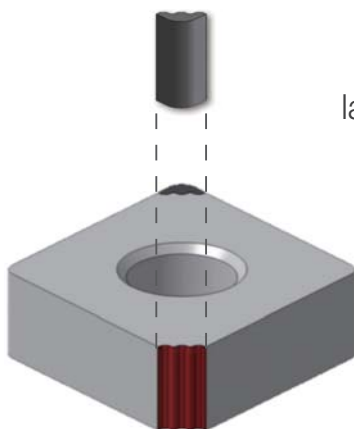

CBN tip size:
Using the cBN tip in a mass as large as **200x** provides increased thermal conductivity and helps reduce the temperature at the cutting edge

Brazing area:
Increased **160%** for enhanced brazing strength

Temperature during machining is concentrated on the CBN tip, reducing temperature issues in the brazing zone.

Workpiece material : SCM420 / 20CrMo4 (60HRC)
Cutting speed : $V_c = 150$ m/min
Feed : $f_z = 0.20$ mm/rev
Depth of cut : $a_p = 0.75$ mm
Coolant : Dry

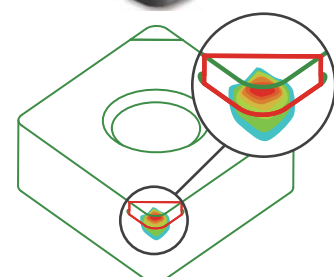
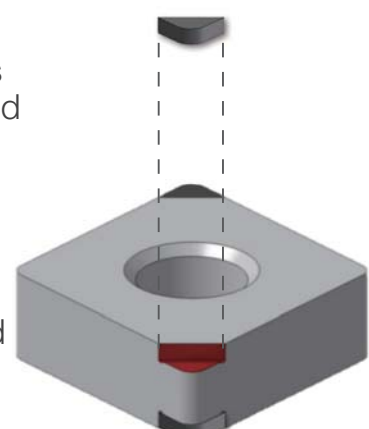

APPLICATION

Hard Turning

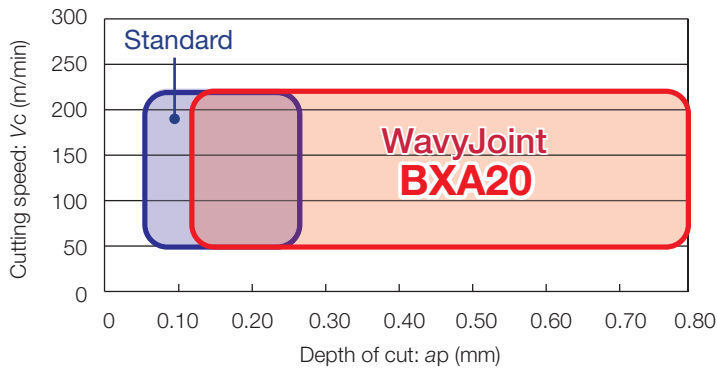

H

WavyJoint BXA20

Great performance for continuous to heavy interrupted cutting at low and medium speeds.

CUTTING PERFORMANCE

Effect of increased brazing area

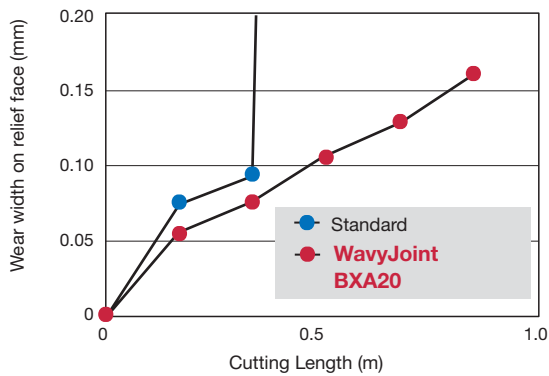

H

Insert : Standard = 2QP-CNGM12408-HM BXA20
 WavyJoint = 4QS-CNGG120408-HM BXA20
 Workpiece material : SCM420 / 20CrMo4 (60HRC) ϕ 63 External turning
 Cutting speed : $V_c = 150$ m/min
 Feed : $f_z = 0.20$ mm/rev
 Depth of cut : $a_p = 0.75$ mm
 Coolant : Dry





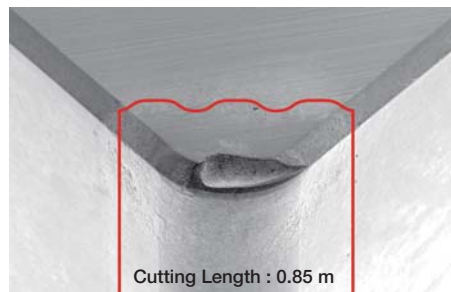





Standard



WavyJoint BXA20

The WavyJoint technology prevents the braze from overheating due to the increase in cutting edge temperature during dry cutting, greatly improving the brazing strength. The result: stable machining and extended tool life.

INSERT

Feature	Shape	Designation	Grade	No. of corners	I. C. dia.	Thick-ness	Hole dia.	Corner radius	CBN length
			Coated						
			BXA20						
					IC	S	D1	RE	LE
Heavy horning		4QS-CNGA120408-H	●	4	12.7	4.76	5.16	0.8	1.5
		4QS-CNGA120412-H	●	4	12.7	4.76	5.16	1.2	1.7
With chipbreaker		4QS-CNGG120408-HM	●	4	12.7	4.76	5.16	0.8	1.5
		4QS-CNGG120412-HM	●	4	12.7	4.76	5.16	1.2	1.7
Heavy horning		4QS-DNGA150408-H	●	4	12.7	4.76	5.16	0.8	1.6
		4QS-DNGA150412-H	●	4	12.7	4.76	5.16	1.2	1.6
With chipbreaker		4QS-DNGG150408-HM	●	4	12.7	4.76	5.16	0.8	1.6
Heavy horning		6QS-TNGA160408-H	●	6	9.525	4.76	3.81	0.8	1.6
		6QS-TNGA160412-H	●	6	9.525	4.76	3.81	1.2	1.8
With chipbreaker		6QS-TNGG160408-HM	●	6	9.525	4.76	3.81	0.8	1.6
Heavy horning		4QS-VNGA160408-H	●	4	9.525	4.76	3.81	0.8	1.7
With chipbreaker		4QS-VNGG160408-HM	●	4	9.525	4.76	3.81	0.8	1.7
Heavy horning		6QS-WNGA080408-H	●	6	12.7	4.76	5.16	0.8	1.5

● : Line-up

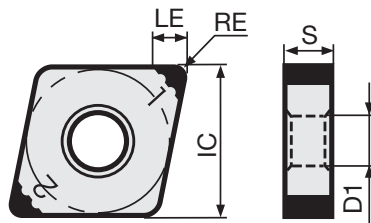

STANDARD CUTTING CONDITIONS

ISO	Workpiece materials	Grade	Work condition	Cutting speed Vc(m/min)	Depth of cut ap (mm)	Feed f (mm/rev)
H	Hardened steel	BXA20	Continuous	50 - 220	0.12 - 0.80	0.10 - 0.30
		BXA20	Interrupted	50 - 200	0.12 - 0.80	0.10 - 0.20

PRACTICAL EXAMPLES

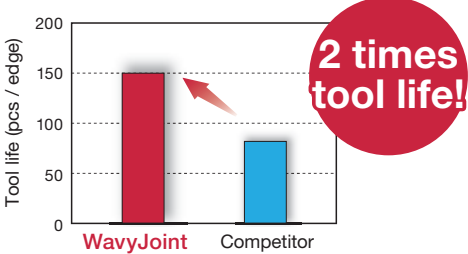
Workpiece type	Automotive part
Insert	4QS-CNGA120412
Grade	BXA20
Workpiece material	SCM420 / 20CrMo4 (60HRC) H
Cutting conditions	
Cutting speed : Vc (m/min)	100
Feed : f (mm/rev)	0.1 - 0.2
Depth of cut : ap (mm)	0.7 - 1.0
Coolant	Dry
Results	 <p>2 times tool life!</p> <p>The WavyJoint technology insert successfully machined 150 pcs/corner, almost twice that of the competitor's, without CBN tip failure.</p>

Tungaloy Corporation (Head office)

11-1 Yoshima-Kogyodanchi
Iwaki-city, Fukushima, 970-1144 Japan
Phone: +81-246-36-8501
Fax: +81-246-36-8542
www.tungaloy.co.jp

Tungaloy America, Inc.

3726 N Ventura Drive
Arlington Heights, IL 60004, U.S.A.
Phone: +1-888-554-8394
Fax: +1-888-554-8392
www.tungaloyamerica.com

Tungaloy Canada

432 Elgin St. Unit 3
Brantford, Ontario N3S 7P7, Canada
Phone: +1-519-758-5779
Fax: +1-519-758-5791
www.tungaloy.co.jp/ca

Tungaloy de Mexico S.A.

C Los Arellano 113,
Parque Industrial Siglo XXI
Aguascalientes, AGS, Mexico 20290
Phone: +52-449-929-5410
Fax: +52-449-929-5411
www.tungaloy.co.jp/mx

Tungaloy do Brasil Ltda.

Avd. Independencia N4158 Residencial Flora
13280-000 Vinhedo, São Paulo, Brasil
Phone: +55-19-38262757
Fax: +55-19-38262757
www.tungaloy.com.br

Tungaloy Germany GmbH

An der Alten Ziegelei 1
D-40789 Monheim, Germany
Phone: +49-2173-90420-0
Fax: +49-2173-90420-19
www.tungaloy.de

Tungaloy France S.A.S.

ZA Courtaboef - Le Rio
1 rue de la Terre de feu
F-91952 Courtaboef Cedex, France
Phone: +33-1-6486-4300
Fax: +33-1-6907-7817
www.tungaloy.fr

Tungaloy Italia S.r.l.

Via E. Andolfato 10
I-20126 Milano, Italy
Phone: +39-02-252012-1
Fax: +39-02-252012-65
www.tungaloy.it

Tungaloy Czech s.r.o.

Turanka 115
CZ-627 00 Brno, Czech Republic
Phone: +420-532 123 391
Fax: +420-532 123 392
www.tungaloy.cz

Tungaloy Ibérica S.L.

C/Miquel Servet, 43B, Nau 7
Pol. Ind. Bufalvent
ES-08243 Manresa (BCN), Spain
Phone: +34 93 113 1360
Fax: +34 93 876 2798
www.tungaloy.es

Tungaloy Scandinavia AB

Bultgatan 38
442 40 Kungälv, Sweden
Phone: +46-462119200
www.tungaloy.se

Tungaloy Rus, LLC

115432, Russian Federation, Moscow,
Andropova avenue., h.18, bld.7, flt. 11,
office 3.
Phone: +7-499-683-01-80/81
www.tungaloy.co.jp/ru

Tungaloy East LLC

620075, Russian Federation, Sverdlovsk
Region, Ekaterinburg, Mamina-Sibiryaka str.,
bldg. 101, room 202
Phone: +7-343-286-48-23/24
Fax: +7-912-284-91-69
www.tungaloy.co.jp/ru

Tungaloy Polska Sp. z o.o.

ul. Genewska 24
03-963 Warszawa, Poland
Phone: +48-22-617-0890
Fax: +48-22-617-0890
www.tungaloy.co.jp/pl

Tungaloy U.K. Ltd

The Technology Centre,
Wolverhampton Science Park
Glaisher Drive, Wolverhampton
West Midlands WV10 9RU, UK
Phone: +44 121 4000 231
Fax: +44 121 270 9694
www.tungaloy.co.jp/uk
salesinfo@tungaloyuk.co.uk

Tungaloy Hungary Kft

Erzsébet királyné útja 125
H-1142 Budapest, Hungary
Phone: +36 1 781-6846
Fax: +36 1 781-6866
www.tungaloy.co.jp/hu
info@tungaloytools.hu

Tungaloy Turkey

Dudullu, OSB 4. Cad No:4
34776 Umraniye Istanbul, TURKEY
Phone: +90 216 540 04 67
Fax: +90 216 540 04 87
www.tungaloy.com.tr
info@tungaloy.com.tr

Tungaloy Benelux b.v.

Tjalk 70
NL-2411 NZ Bodegraven, Netherlands
Phone: +31 172 630 420
Fax: +31 172 630 429
www.tungaloy-benelux.com

Tungaloy Croatia

Josipa Kozarca 4
10432 Bregana, Croatia
Phone: +385 1 3326 604
Fax: +385 1 3327 683
www.tungaloy.hr

Tungaloy Cutting Tool (Shanghai) Co., Ltd.

Rm No 401 No.88 Zhabei
Jiangchang No.3 Rd
Shanghai 200436, China
Phone: +86-21-3632-1880
Fax: +86-21-3621-1918
www.tungaloy.co.jp/tots

Tungaloy Cutting Tool (Thailand) Co., Ltd.

Interlink tower 4th Fl.
1858/5-7 Bangna-Trad Road
km.5 Bangna, Bangna, Bangkok 10260
Thailand
Phone: +66-2-751-5711
Fax: +66-2-751-5715
www.tungaloy.co.th

Tungaloy Singapore (Pte.), Ltd.

62 Ubi Road 1, #06-11 Oxley BizHub 2
Singapore 408734
Phone: +65-6391-1833
Fax: +65-6299-4557
www.tungaloy.co.jp/tspl

Tungaloy Vietnam

LE 04-38, Lexington Residence
67 Mai Chi Tho, Dist. 2,
Ho Chi Minh City, Vietnam
Phone: +84-8-37406660
Fax: +84-8-37406662
www.tungaloy.co.jp/tspl

Tungaloy India Pvt. Ltd.

Indiabulls Finance Centre,
Unit # 902-A, 9th Floor,
Tower 1, Senapati Bapat Marg,
Elphinstone Road (West),
Mumbai -400013, India
Phone: +91-22-6124-8804
Fax: +91-22-6124-8899
www.tungaloy.co.jp/in

Tungaloy Korea Co., Ltd

#1312, Byucksan Digital Valley 5-cha
Beotkot-ro 244, Geumcheon-gu
153-788 Seoul, Korea
Phone: +82-2-2621-6161
Fax: +82-2-6393-8952
www.tungaloy.co.jp/kr

Tungaloy Malaysia Sdn Bhd

50 K-2, Kelana Mall, Jalan SS6/14
Kelana Jaya, 47301
Petaling Jaya, Selangor Darul Ehsan
Malaysia
Phone: +603-7805-3222
Fax: +603-7804-8563
www.tungaloy.co.jp/my

Tungaloy Australia Pty Ltd

PO Box 2232, Rowville,
Victoria 3178, Australia
Phone: +61-3-9755-8147
Fax: +61-3-9755-6070
www.tungaloy.com.au

PT. Tungaloy Indonesia

Kompleks Grand Wisata Block AA-10 No.3-5
Cibitung
Bekasi 17510, Indonesia
Phone: +62-21-8261-5808
Fax: +62-21-8261-5809
www.tungaloy.co.jp/id



www.tungaloy.com

follow us at:

facebook.com/tungaloyjapan

twitter.com/tungaloyjapan

To see this product in action visit:

Tung-TV

www.youtube.com/tungaloycorporation

Distributed by:



DOWNLOAD
Dr. Carbide App



FIND US ON THE CLOUD!
machiningcloud.com



Available on the
App Store



GET IT ON
Google play



AS9100 Certified
78006
2015.11.04
ISO14001 Certified
EC97J1123
1997.11.26

Produced from Recycled paper

Jun. 2018 (TJ)